

Surface Mount Schottky Barrier Rectifier  
 Reverse Voltage - 60V  
 Forward Current - 5.0A

#### FEATURES

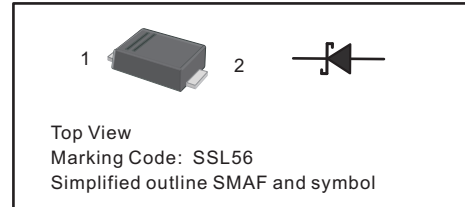
- Metal silicon junction, majority carrier conduction
- For surface mounted applications
- Low power loss, high efficiency
- High forward surge current capability
- For use in low voltage, high frequency inverters, free wheeling, and polarity protection applications

#### MECHANICAL DATA

- Case: SMAF
- Terminals: Solderable per MIL-STD-750, Method 2026
- Approx. Weight: 27mg / 0.00095oz

#### PINNING

PIN	DESCRIPTION
1	Cathode
2	Anode



#### Maximum Ratings and Electrical characteristics

Ratings at 25 °C ambient temperature unless otherwise specified.

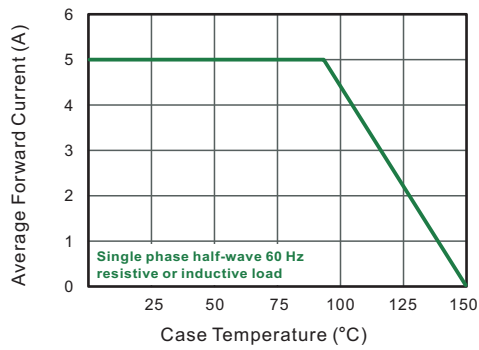
Single phase half-wave 60 Hz, resistive or inductive load, for capacitive load current derate by 20 %.

Parameter	Symbols	SSL56F	Units
Maximum Repetitive Peak Reverse Voltage	$V_{RRM}$	60	V
Maximum RMS voltage	$V_{RMS}$	42	V
Maximum DC Blocking Voltage	$V_{DC}$	60	V
Maximum Average Forward Rectified Current	$I_{F(AV)}$	5	A
Peak Forward Surge Current 8.3 ms Single Half Sine Wave Superimposed on Rated Load	$I_{FSM}$	150	A
Maximum Instantaneous Forward Voltage at 5A	$V_F$	0.5	V
Maximum DC Reverse Current at Rated DC Blocking Voltage	$I_R$	$T_a = 25\text{ }^\circ\text{C}$ 1.0	mA
		$T_a = 100\text{ }^\circ\text{C}$ 50	
Typical Junction Capacitance <sup>(1)</sup>	$C_j$	500	pF
Typical Thermal Resistance <sup>(2)</sup>	$R_{\theta JA}$	45	°C/W
Operating Junction Temperature Range	$T_j$	-55 ~ +150	°C
Storage Temperature Range	$T_{stg}$	-55 ~ +150	°C

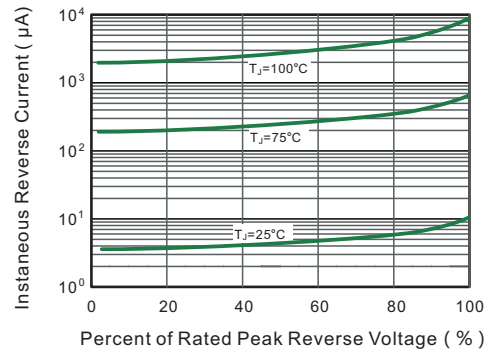
(1) Measured at 1 MHz and applied reverse voltage of 4 V D.C

(2) P.C.B. mounted with 2.0" X 2.0" (5 X 5 cm) copper pad areas.

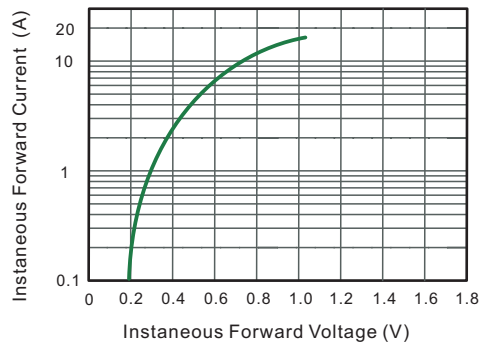
**Fig.1 Forward Current Derating Curve**



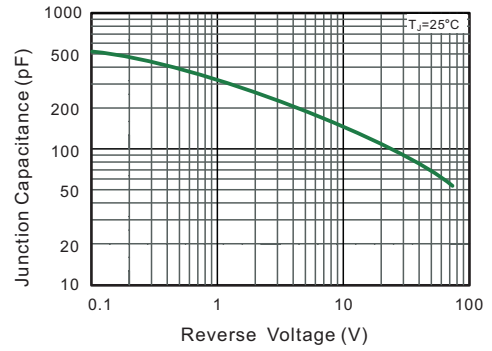
**Fig.2 Typical Reverse Characteristics**



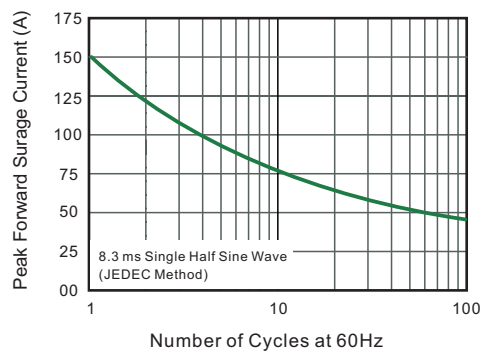
**Fig.3 Typical Forward Characteristic**



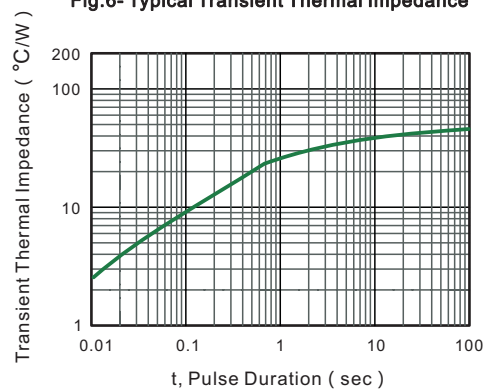
**Fig.4 Typical Junction Capacitance**



**Fig.5 Maximum Non-Repetitive Peak Forward Surge Current**

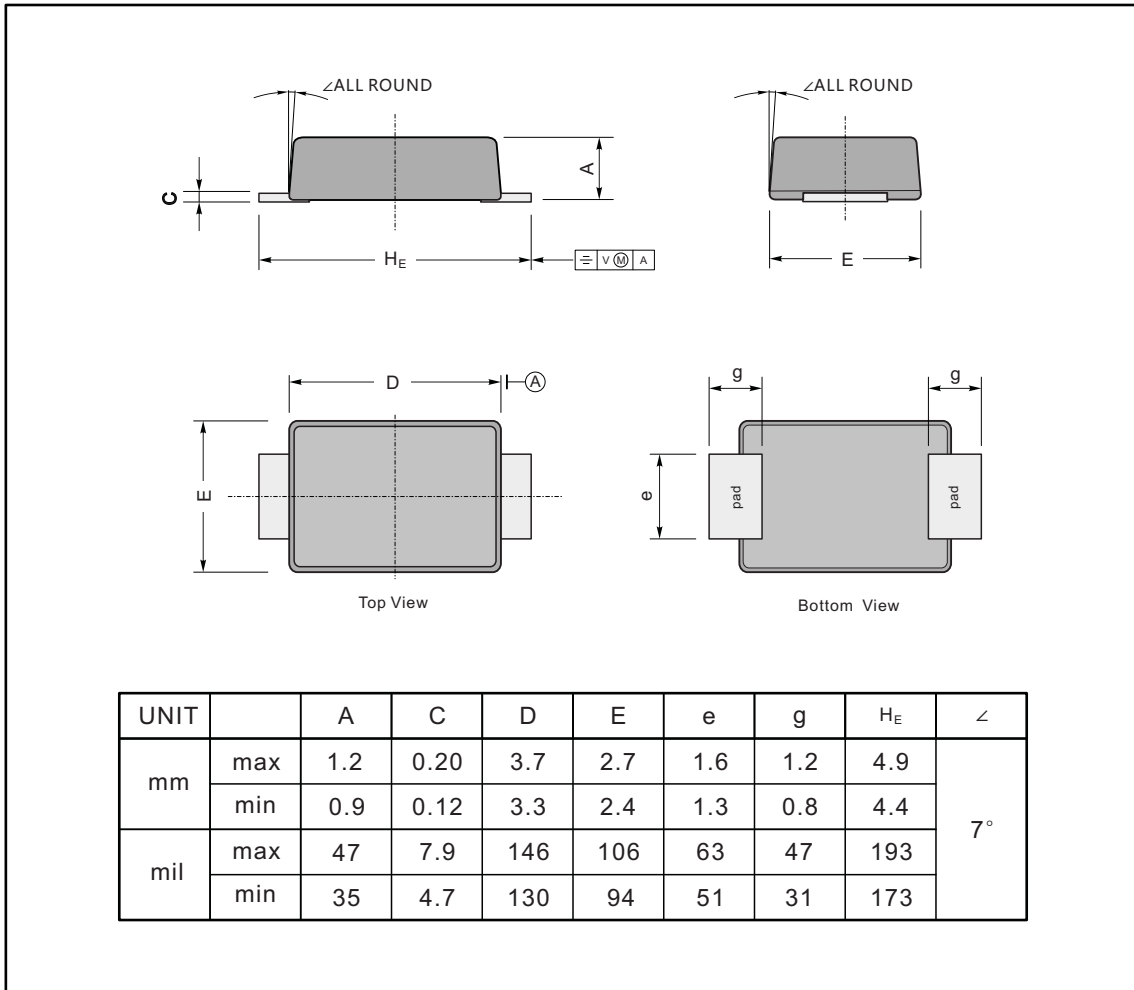
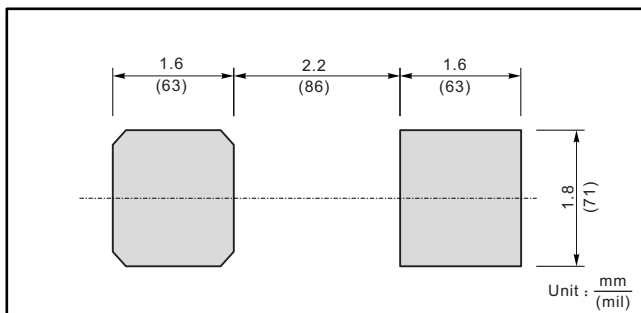


**Fig.6- Typical Transient Thermal Impedance**



**PACKAGE OUTLINE**

Plastic surface mounted package; 2 leads

**SMAF**

**The recommended mounting pad size**

**Marking**

Type number	Marking code
SSL56F	SSL56